



Metal-Wood Stair Systems & Railing

www.stairsolutions.com

770-813-9070

Alpharetta, Georgia



Red Oak 4000 Newels, 6084 Handrail with stainless round bar bracket (shown)

Create the ideal modern aesthetic by combining stainless steel cable and rich oak. The expansive views allowed for by cable make it ideal for balconies as well as staircases.

Modern Handrail

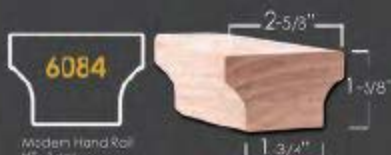

6084

Modern Hand Rail
Ht. 1-5/8"
W. 2-5/8"

6084 Straight Rail
6084-B Bending Rail
no fittings available



6002

Modern Hand Rail
Ht. 1-5/8"
W. 2-3/4"

6002 Straight Rail
6002-B Bending Rail
no fittings available

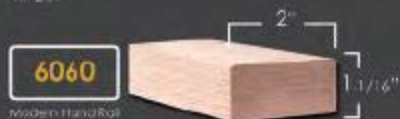

6060

Modern Hand Rail
Ht. 1-1/4"
W. 2"

6060 Straight Rail
no fittings available

* All wood parts stocked in Red Oak end



ROUND NEWEL

(Newels or bars can be cut to length for handrail brackets)

ROUND STAINLESS NEWEL

HF17.1.2-T
Ends: 1-3/16" R4
Height: 47"
Wt. 5.7 lbs.
TUBULAR

FF 16.5.11
Ends: 1-3/16" R4
Height: 48"
Wt. 19 lbs.
SOLID

FF 16.5.11-T
Ends: 1-3/16" R4
Height: 48"
Wt. 5.7 lbs.
TUBULAR

Wall Mount Handrail Bracket



mounting hardware included



HF 17.4002
Stainless Steel(304)
Ht. 2-1/2"
Base = 1-1/2" x 2"
Extends 3-1/4" off wall
ADJUSTABLE

HFSTB 17.4002
Satin Black
Ht. 2-1/2"
Base = 1-1/2" x 2"
Extends 3-1/4" off wall
ADJUSTABLE

Newel Mount Handrail Bracket



mounting hardware included



HF 17.4001
Stainless Steel(304)
Ht. 1-3/4"
Rise = 1-1/2" sq.
ADJUSTABLE

HFSTB 17.4001
Satin Black
Ht. 1-3/4"
Base = 1-1/2" sq.
ADJUSTABLE

Cable Gripping Pliers



HFC18.PLIER

Cable Cutter



HFC18.CUTTER

Insert Tube



Length: 1-1/2"
HFC18.TUBE

Release Key



HFC18.KEY

Cable Cut-off Wheel



HFC18.WHEEL



Lag Bolt Driver



DRIVER PL-LAG/R

For use with WLR1/R1 swageless cable fitting

Stainless Cleaner-Protectant



HFC18.CLEAN

CABLE, HANDRAIL, TREADS

Cable Fittings for Metal Newels

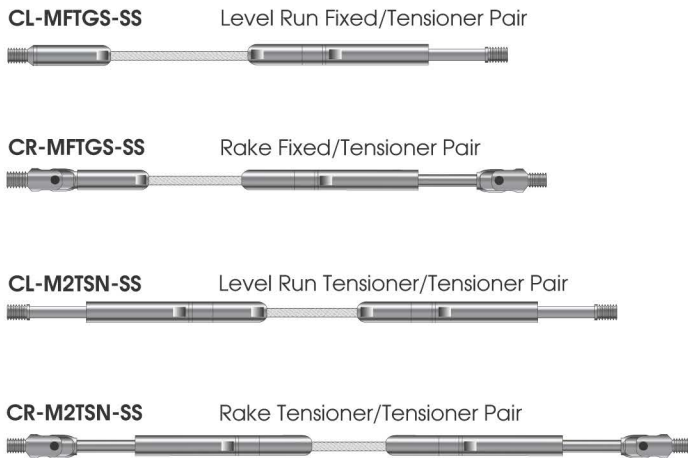

Cable Fittings for Wood Newels

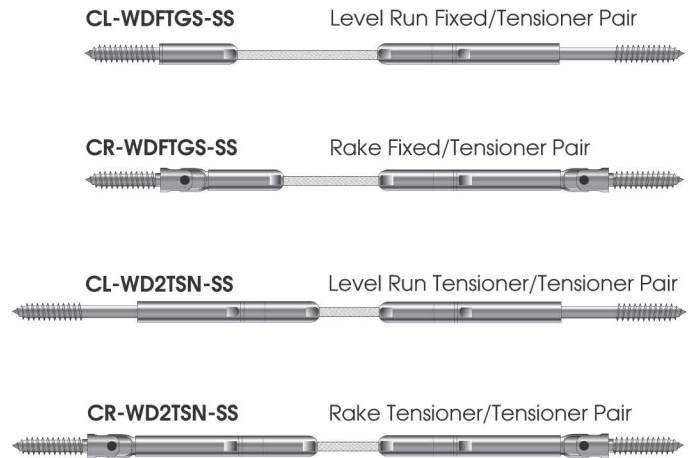

1/8" Marine Grade 316
Stainless Steel Cable
(1x19 construction)

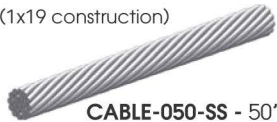

CABLE-050-SS - 50' Roll
CABLE-150-SS - 150' Roll
CABLE-500-SS - 500' Roll

Cable Release
Tool



C-RELEASE

Cable Cutter



C-CUTTER

Stainless Steel
Cleaner &
Protectant



C-CLEANER

Post Protector Tube
(For wood newels only)

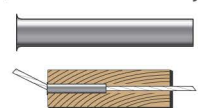

C-PROTECTOR

Handrail and Handrail Fittings



684
Handrail
2 5/8" x 1 5/8"



784QTR
Quarterturn



784UE
Up easing



784OE
Over easing



784LHGN
Left Hand
Gooseneck



784RHGN
Right Hand
Gooseneck



784SGN
Straight
Gooseneck

Treads, Risers, Landing Tread, False Treads



LJ-8870
Square Nose Plain Tread
1" x 11-1/2"
Lengths: 42", 48", 54"



LJ-88701RV
Square Nose Tread with
Miter Return on 1 End
(Reversible)
1" x 11-1/2"
Lengths: 42", 48", 54"



LJ-8870MR2
Square Nose Tread with
Miter Return on Both
Ends
1" x 11-1/2"
QUOTED ITEM



LJ-8075
Riser
3/4" x 7 1/2" or 8"
Lengths: 42", 48", 54"



BOXTRD
Face Laminated Solid Tread
3-1/2" x 11-1/2"
Lengths: 42", 48"



LJ-8879
Square Nose False Tread Kit
7-5/16" x 12-5/8"
For open tread left hand,
open tread right hand or
closed tread applications.



LJ-8890-5
Square Nose Landing Tread
5-1/4" x random length



LJ-8895
Cove/Shoe/Trim Moulding
3/4" x 3/4" x random length

— Stainless Steel —
Cable Railing

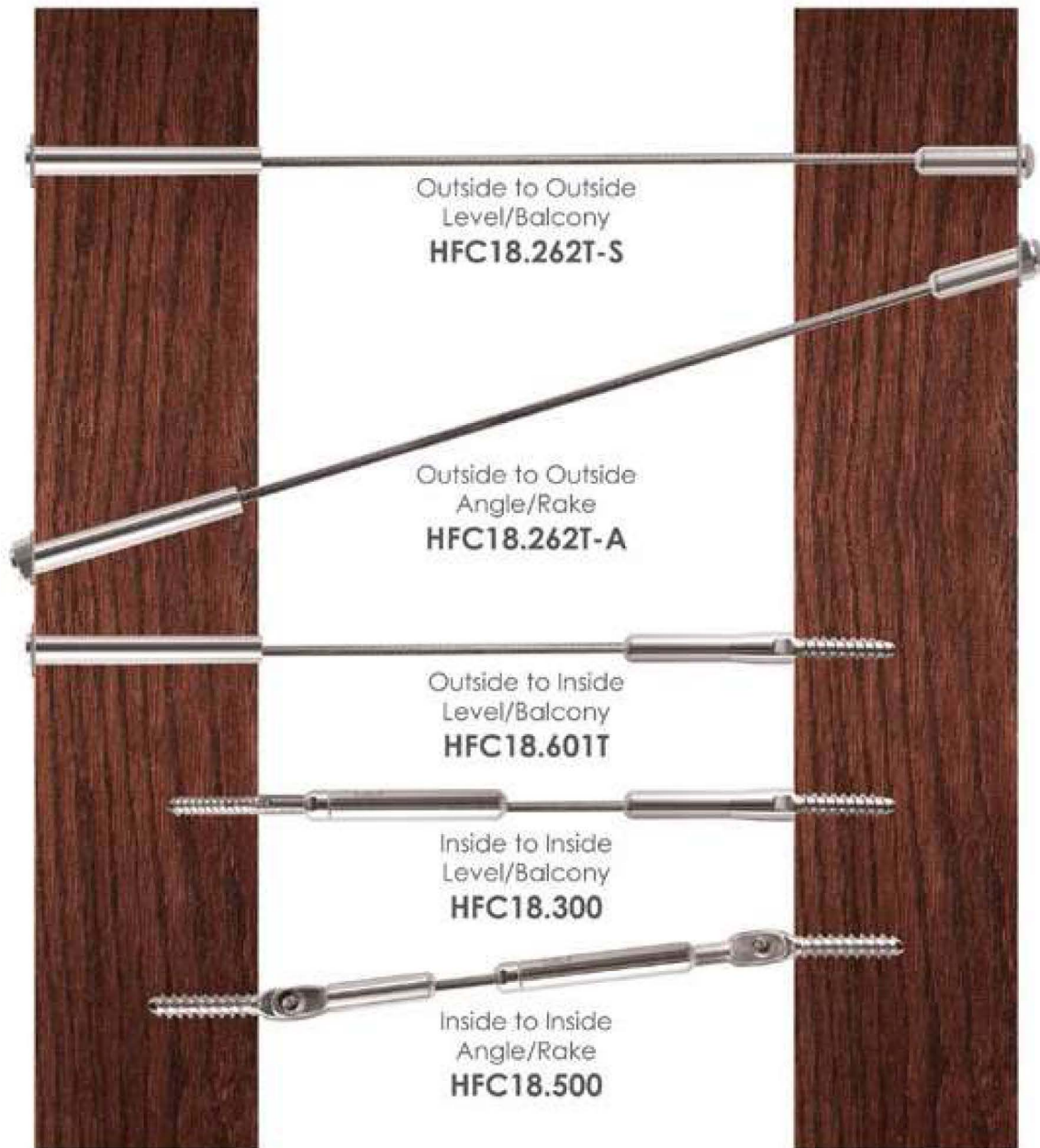

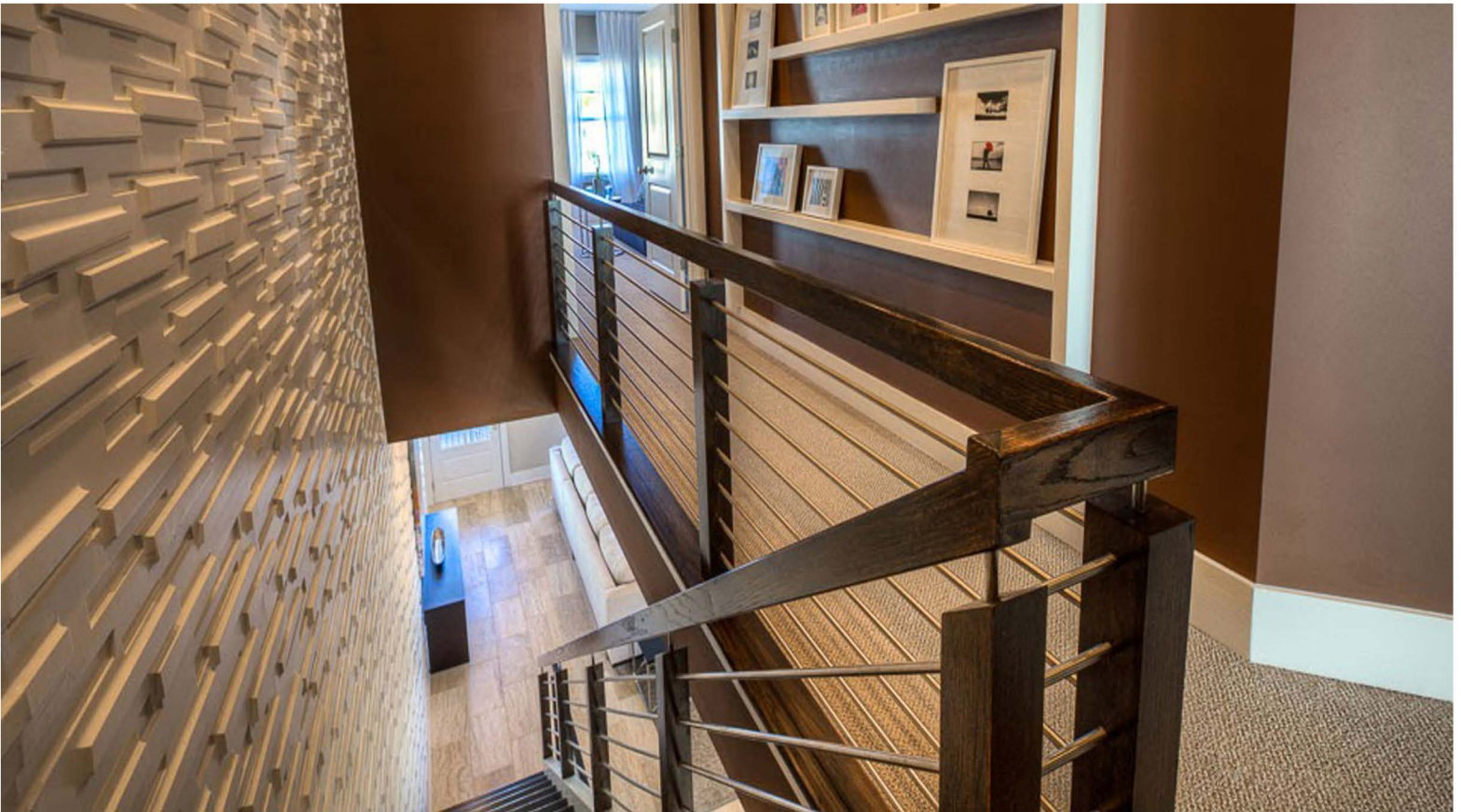









CONFIGURATIONS

STRAIGHT

WITH 1 TURN

WITH 2 TURNS

With winder steps

With winder steps

With landing

With landings



Spectrum

Railing System

A Square Post System With Many Options COST: \$ \$ \$ \$

The Spectrum System features pre-drilled square posts and fittings to surface or fascia mount the posts and mount handrails. The cable infill offers a choice between using 1/8" or 5/32" cable with HandiSwage™ Studs. You can find installation instructions at www.atlantisrail.com or by asking your Atlantis Rail Sales Representative for more information. Customers must source their own hardwood flat handrail (minimum 2" x 4"). Choose from the colors below.



COLOR SELECTION



Colors from top, left to right: Black, Metallic Silver, Pure White, Dark Brown, Pebble Grey and Light Brown.

**Uncoated option available upon request.*

CABLE INFILL OPTION

HandiSwage™

The Spectrum System is available using a 5/32" or 1/8" diameter cable and HandiSwage™ Studs, making it one of the simplest and most economical cable railing systems available. All the studs, cable and accessories are made from electro-polished 316L stainless steel for maximum corrosion resistance and durability. For a finished look, we offer a variety of cover nut sets including multiple styles and colors.



SKY Spiral Staircase

Interior/Exterior Painted Steel

This versatile indoor or outdoor steel staircase can be installed with either a clockwise or counter clockwise twist. It is available in three colors and is delivered powder coat finished and ready to install.

Kit is shipped with detailed assembly instructions and an installation DVD.

Available in Black, White or Grey

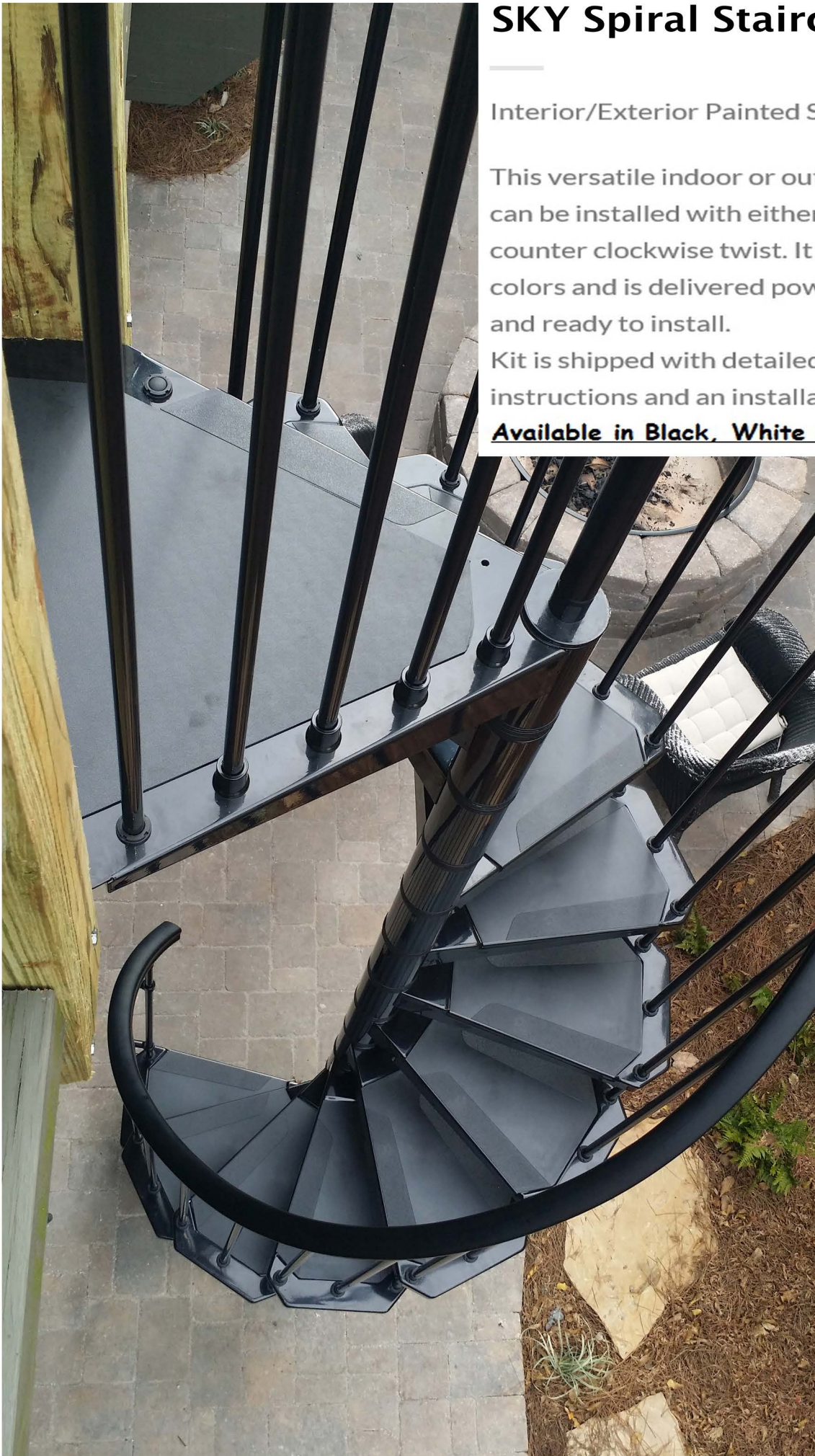

MEASUREMENTS valid for all the configurations

The SYSTEM FOR ADJUSTING THE HEIGHT BETWEEN THE STEPS (RISE) allows you to:

- Obtain different heights between floors with the same number of steps.
- Obtain the height between the floors as required with more or fewer steps (this means you can find the best compromise between the step height and the space occupied by the staircase).

ADJUSTABLE RISE

Height between steps

Min. 8' 1/8" - 20,5 cm
Max. 9' 1/2" - 24 cm

During installation it is possible to adjust the rise by changing the number of spacers

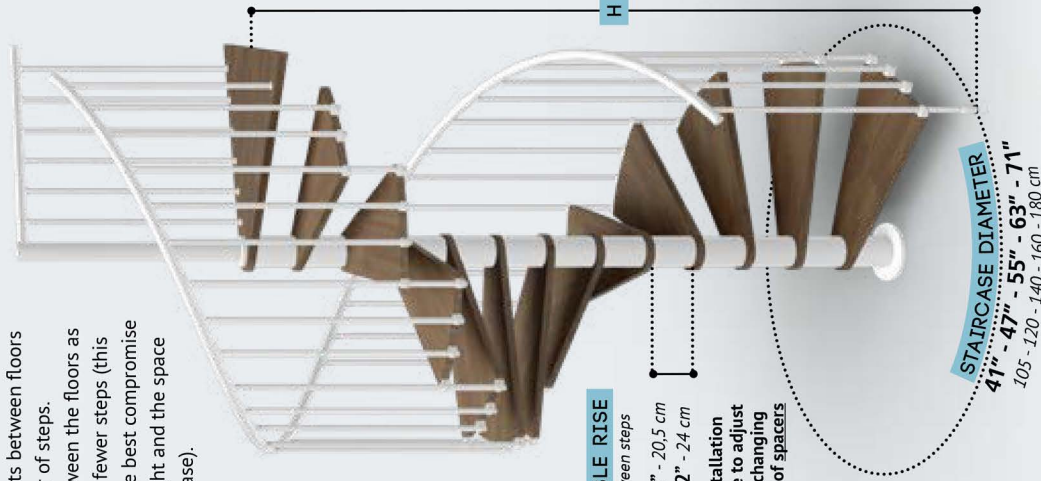

STAIRCASE DIAMETER
41" - 47" - 55" - 63" - 71"
105 - 120 - 140 - 160 - 180 cm

N. STEPS	HEIGHT BETWEEN FLOORS (H)
10 steps 1 box	Min. 6' 8 3/4" - 205 cm Max. 7' 10 1/2" - 240 cm
11 steps 1 box	Min. 7' 5" - 226 cm Max. 8' 8" - 264 cm
12 steps 1 box	Min. 8' 1" - 246 cm Max. 9' 5 3/8" - 288 cm
13 steps 1 box	Min. 8' 9 1/8" - 267 cm Max. 10' 2 7/8" - 312 cm
14 steps 1 box + 1 extra step	Min. 9' 5" - 287 cm Max. 11' 1/4" - 336 cm
15 steps 1 box + 2 extra steps	Min. 10' 1 1/4" - 308 cm Max. 11' 9 3/4" - 360 cm
16 steps 1 box + 3 extra steps	Min. 10' 9 1/8" - 328 cm Max. 12' 7 1/8" - 384 cm

Add more steps to reach greater heights.

- H = Finished floor to finished floor height.
- Top universal landing fixed at the same level as the finished upper floor.
- Ceiling opening diameter: staircase diameter + 2" (5 cm).

DIRECTION OF ASCENT

Clockwise



ACCESSORIES

Wooden handrail (not available for the diam. 5' 5 3/8" - 105 cm)



Balustrade for upper floor 39" (100 cm).



Extra section of internal post (needed for heights over 10' 5 5/8" - 319 cm)



Extra step (with structure and railing).



HANDRAIL & FITTINGS

6040



6040
Round Wall Rail
Diameter: 1-5/8"

RETURNED END



- 7009
- 7209
- 7709

6010

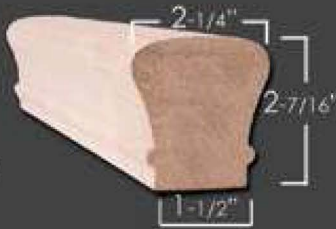

Colonial Hand Rail
HT. 2-3/8"
W. 2-5/8"

6010 Straight Rail
6010-B Bending Rail
bending rail includes moulding

OPENING CAP



- 7019
- 7219
- 7719

6210



Traditional Hand Rail
HT. 2-3/8"
W. 2-5/8"

6210 Straight Rail
6210-B Bending Rail
bending rail includes moulding

TANDEM CAP



- 7020
- 7220
- 7720

6710

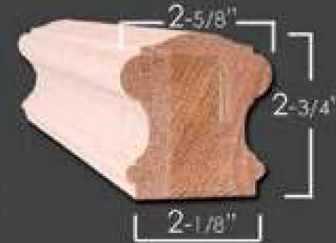

Prestige Hand Rail
HT. 2-3/4"
W. 2-5/8"

6710 Straight Rail
6713 Bending Rail
bending rail includes moulding

OVER EASING



- 7013
- 7213
- 7713

6002

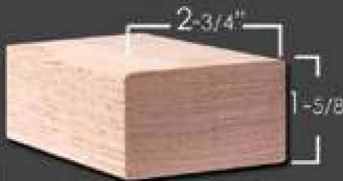

Modern Hand Rail
HT. 1-5/8"
W. 2-3/4"

6002 Straight Rail
Available in 8' & 16'
no fittings available

UP EASING 90 DEGREE



- 7012
- 7212
- 7712
- 7014
- 7214
- 7714

6084

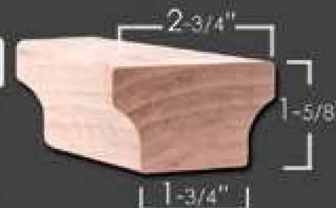

Modern Hand Rail
HT. 1-5/8"
W. 2-3/4"

6084 Straight Rail
Available in 8' & 16'
no fittings available

START EASING WITH CAP



- 7010
- 7210
- 7710

All handrail and fittings stocked in Red Oak (RO)

Product Summary

Box Newels



4075	4290	4291-ADJ	4091	4077	4695/4691	4095	4891-FP	4891-RP	4090	4690	4790	4890	4092	4094
Page 14				Page 16		Page 17		Page 18		Page 19				

Post-to-Post Systems



4040/4042	4540/4542	4550/4555	4001/4002	4240/4242	4004/4005	4070	4840/4845	4172/4175	4179	4280/4280L	4282/4282L	4440/4442	4074/4076	3040/3042
4045/4046	4545/4546	4556	4003/4007	4245	4006			4176		4285	4287	/4445/4446		3045/3046
4055	4547/4548		4008/4009											
Page 25			Page 26		Page 27-28			Page 28		Page 29	Page 30	Page 31	Page 31	Page 32

Over-the-Post Systems



4010/4011	4014	4019	4030/4035	4065	4210/4211	4662	4810/4815	4862	4111/4115	4270/4275	4272/4277	4410/4415	4419	3010/3011
4015					4215									3015
Page 24					Page 26		Page 27		Page 28	Page 29	Page 30	Page 31	Page 32	

Post to Post Newel Systems



Over the Post Newel Systems

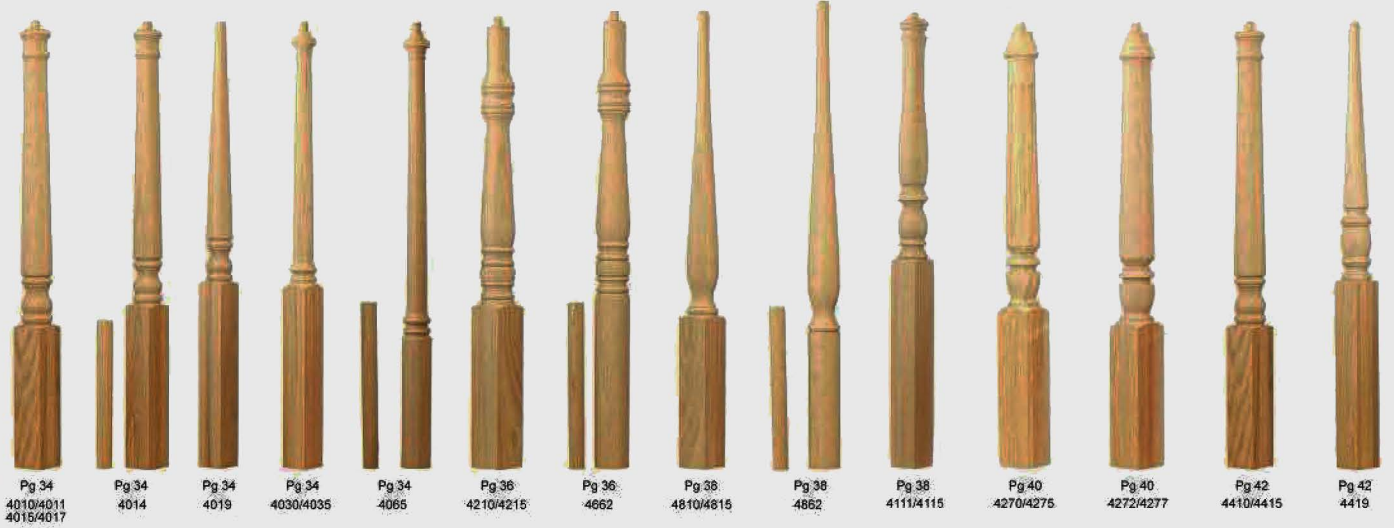

Box Newels

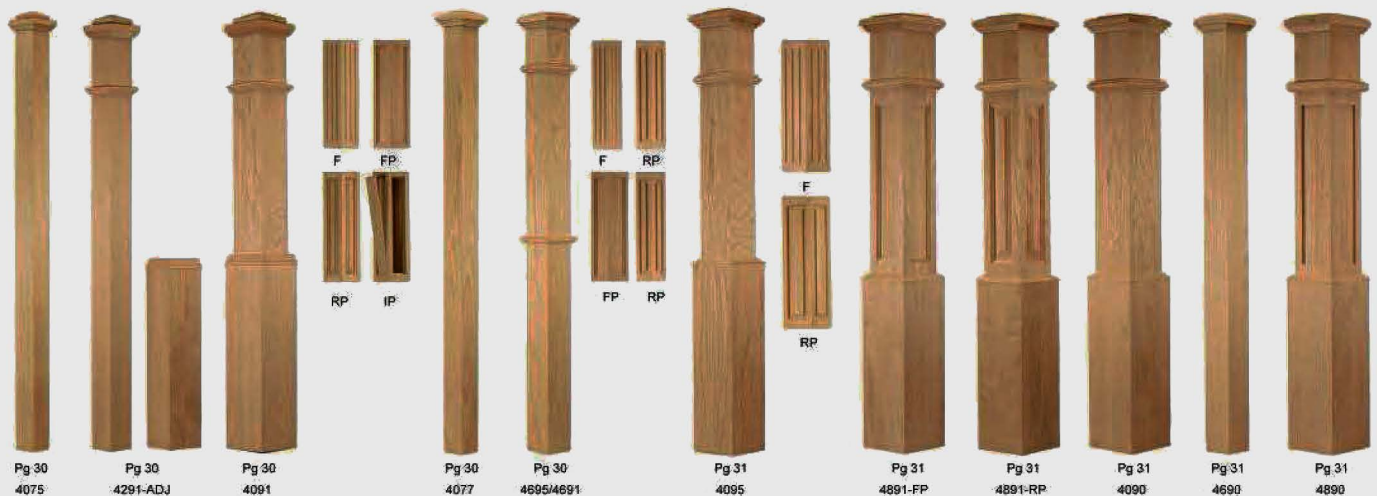

Treads

Please contact us for a quote on special dimensions.

Oak treads and Risers available engineered or solid (edge glued). Specify "OE" or "OS."

PLAIN



8070-36" 8070-84"
 8070-42" 8070-96"
 8070-48" 8070-120"
 8070-54" 8070-144"
 8070-60" 8070-192"
 8070-72"

REVERSIBLE RETURN



8070R-42" 8070R-60"
 8070R-48" 8070R-72"
 8070R-54" 8070R-96"

RETRO TREAD



8070RETRO-42"
 8070RETRO-48"
 8070RETRO-60"
 808013RETRO

HYBRID



HY8070RR-48"
 HY8070RR-60"

DOUBLE RETURN



8070DR-48"
 8070DR-54"
 8070DR-60"



8070-*custom
 specify inside dimension



C-8010COVE
 Complete Set C-8010 Cove Moulding (60")
C-8095 Profile

C-8010SHOE
 Complete Set C-8010 Shoe Moulding (60")
C-8085 Profile

C-8015COVE
 Complete Set C-8015 Cove Moulding (60")
C-8095 Profile

C-8015SHOE
 Complete Set C-8015 Shoe Moulding (60")
C-8085 Profile

Starting steps are shipped complete with the starting riser, starting tread, and all cove and shoe moulding.

Hardware and Accessories

WALL RAIL BRACKETS

*Finish color may vary

Heavy Duty



Medium Duty



NEWEL INSTALLATION KITS



MISCELLANEOUS TOOLS & HARDWARE



1/2" Iron Baluster Options

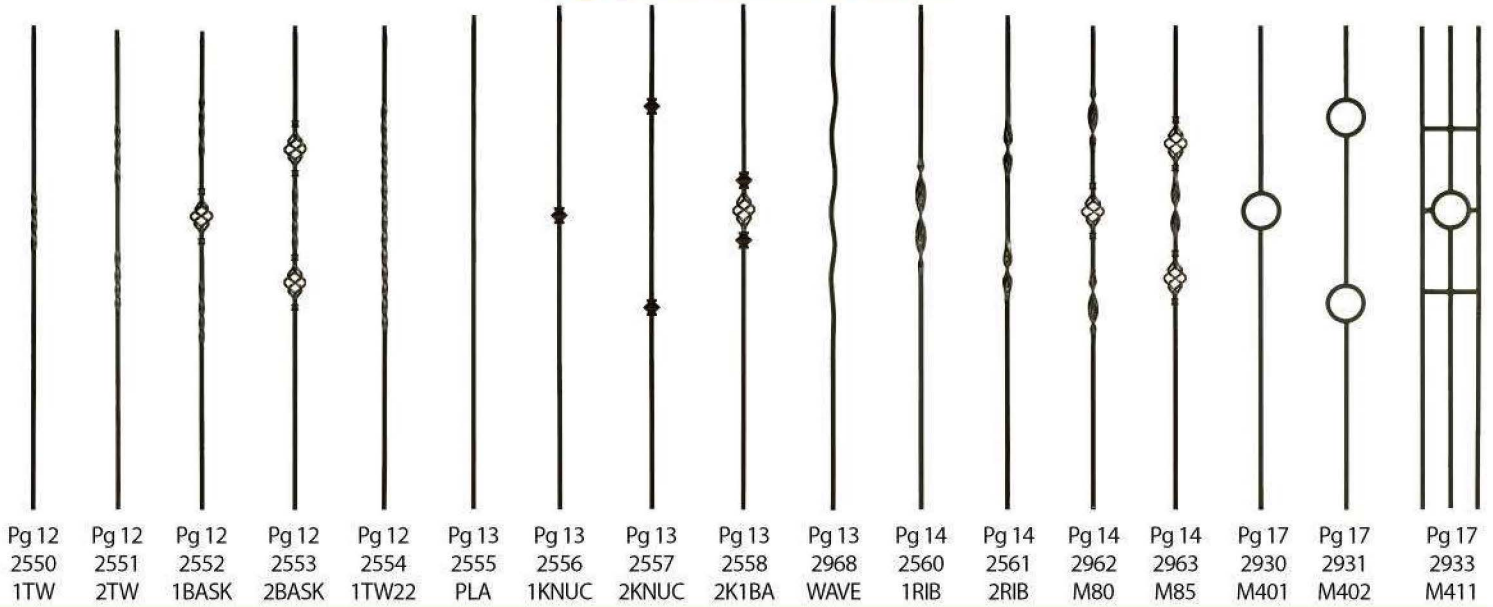

Knee Wall Series - 1/2"

Scroll Series - 1/2"

Belly Series - 1/2"

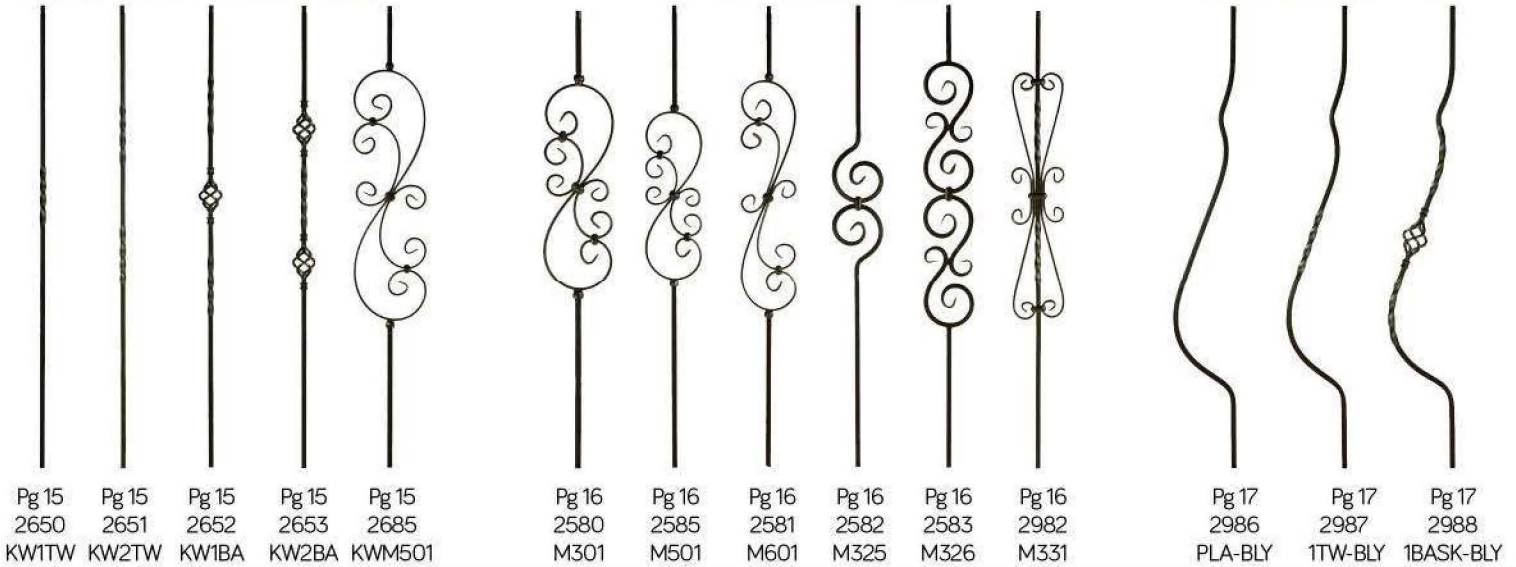

Decorative Panels - 1/2"

1/2" Shoes

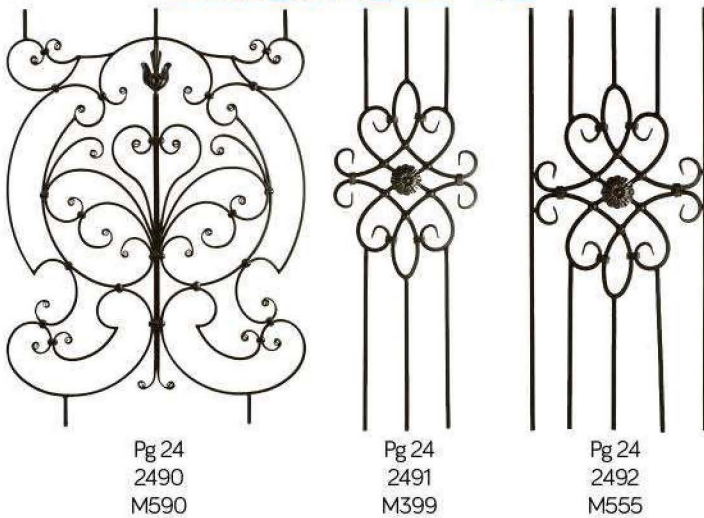

ALUMINUM



BALUSTERS

Round & Square

Round

- 3/4" Diameter
- 26", 32" and 36" Lengths
- Available in all Colors
- 29" Length - Black and Hammered Bronze Only



Square

- 3/4" Diameter
- 26", 32" and 36" Lengths
- Available in Most Colors
- 29" Length - Black and Hammered Bronze Only



Face Mount



- Face Mount, Bow & Belly
- Available in Satin Black, Satin Bronze, Hammered Bronze, Text. Black & Text. Bronze
- Color Matched Screws Included

Belly



Bow



Glass Balusters

- 4" Clear Tempered Glass
- 26" and 32" Lengths
- Available for Level and Stair
- Connectors in Black, Bronze & White

Glass Baluster Connectors



Baluster Connectors

Standard Connectors (Level & Stair)



Architectural Connectors (Level & Stair)



Connectors for 3/4" Balusters

- Used for Round and Square Balusters
- Level and Stair Applications
- Available in Multiple Colors
- Simple Installation Saves Time
- Stainless Steel Screws Included



WWW.DEKPROMFG.COM

2x4 Railing Connectors



- ### 2x4 Connectors
- Level, 45°, and Stairs
 - Four Color Options: Black, Bronze, Cedar and Gray
 - Color Matched Screws Included

Slide Over Accessories

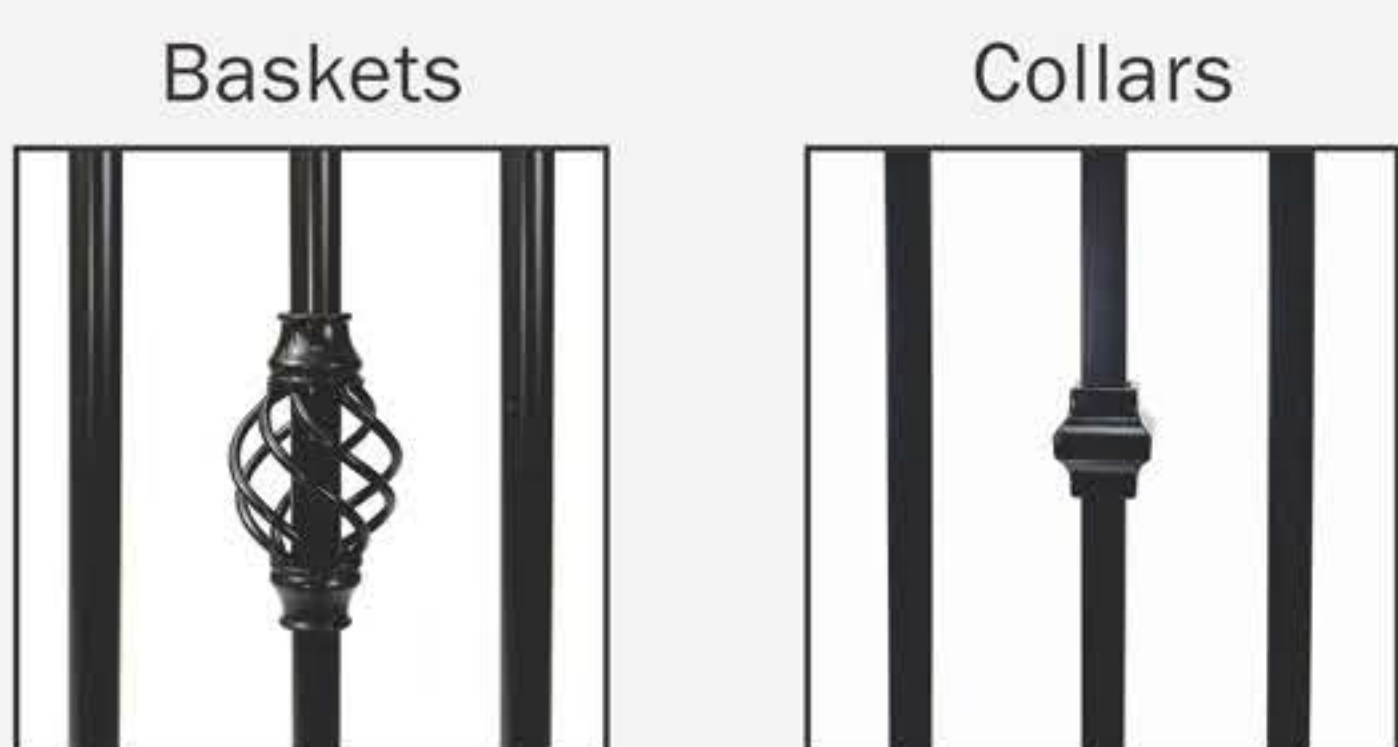

*Only Available in Smooth Black Finish for both Round and Square

Baluster Features

- Low Maintenance
- Affordable
- Stylish
- Quick & Easy Installation
- Use with Wood, Composite and Vinyl
- AAMA 2604 Powder Coat
- Smooth and Textured Finishes
- Available in 11 colors
- Powder Coated Baluster Ends
- Limited Lifetime Warranty



Available Colors:



*Colors shown are representation only. See actual product when selecting

DekPro™ EFFEX Post Caps Shown



WWW.DEKPROMFG.COM



DekPro™ Balusters Available Thru:

Marketed and Distributed by:
Absolute Distribution Inc.

www.absolutedist.com



WWW.DEKPROMFG.COM

L02DPBALBROCH2018 ©2018 Absolute Distribution Inc. All rights reserved

Quality Aluminum Balusters

ADA Compliant Handrail

Code compliant for Type I Graspability requirements, this 1-1/2" diameter round handrail is available in all seven Aluminum AFCO-Rail powder coat finishes. Using an internal connector, the various system components can be joined together to create the full run of ADA Compliant Handrail needed for the job.



ADA Compliant Handrail Components



Handrail Available in 8' and 10'



Handrail Bracket

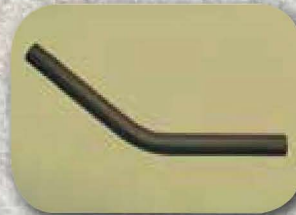

Handrail Transition Elbows Available in 38°, 34°, 32°, 5° and 90°



D Loop



Wall / Post Return



Flat End Plug



Internal Splice Lock

Available in all seven AFCO-Rail finishes

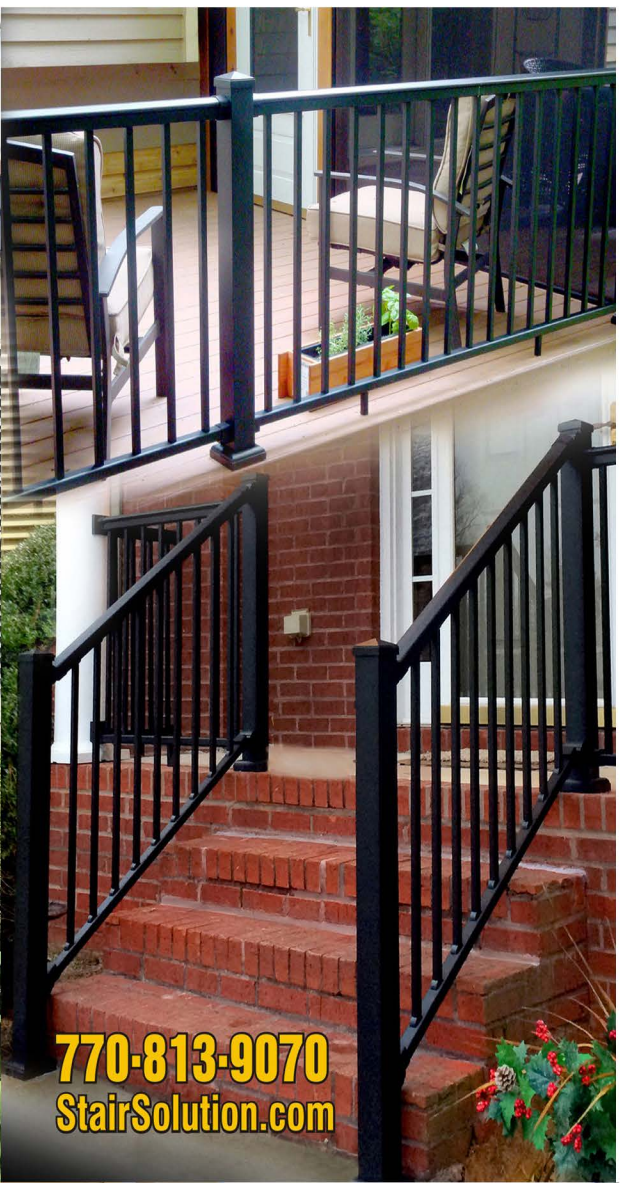

- Always Available In-Stock
- Strong & Reliable
- Exceeds Handrail Building Codes
- Very Simple DIY Installation
- Increases Home Value
- Promotes Safe Mobility
- Durable Powder Coated Finish

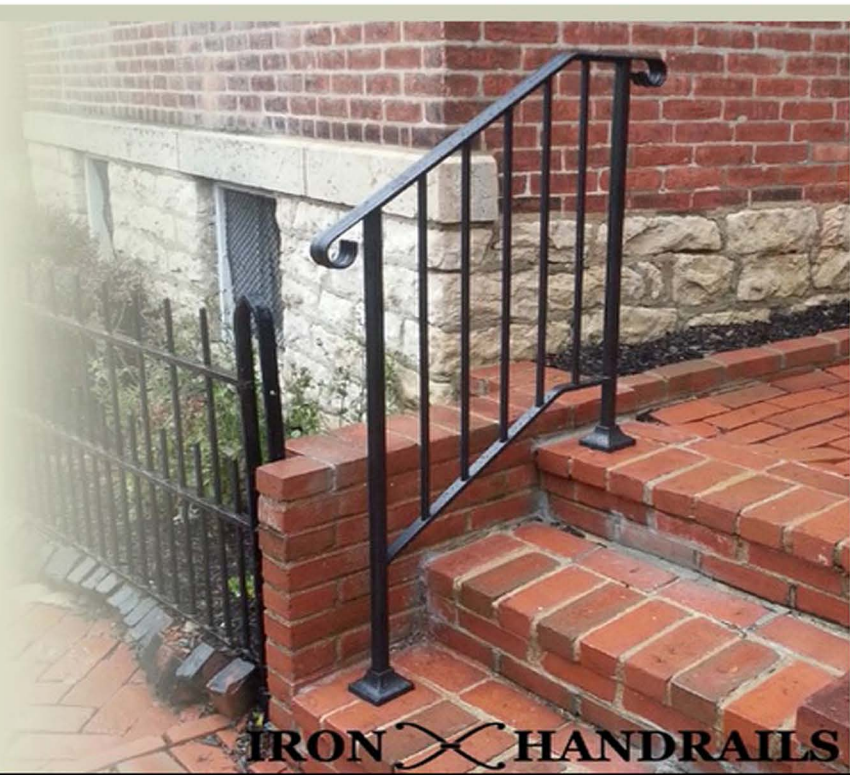

IRON X HANDRAILS

**You have found
THE STRONGEST & MOST RELIABLE
D.I.Y. HANDRAIL AVAILABLE**

**S110 Steel Railing
Pre-Assembled Panel**

- Safe, strong and durable
- Quick and easy installation
- Low maintenance
- Pre-assembled panels come in 28", 34" or 40" heights; 70" or 94" widths
- Available in level and stair application – stair adjustable up to 42 degrees
- Use with post sleeves or wood
- Steel posts are available in 2" or 3"
- Panel can be used as infill between vinyl or composite
- Superior coating performance – galvanized steel with 2604 compliant powder coating
- 15-year limited warranty

Available Colors



BLACK SAND



ANTIQUÉ BRONZE



PANEL SYSTEM

This collection consists of preassembled panels resulting in a very simplified installation process for open tread stairs, kneewall stairs and level run applications. This system is for interior use only.

Our Linear Panels can be pre-built to fit and only need a few screw holes drilled for installation. No glue needed, no sanding, no drilling of baluster holes, no marking and cutting to fit.

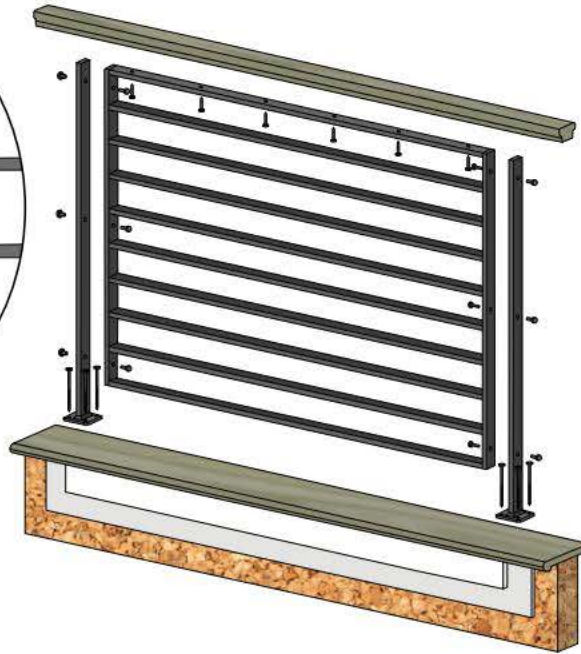
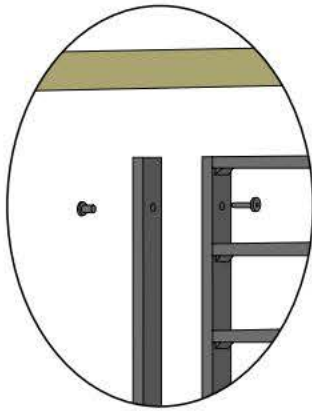

Installation Instructions are available on our website www.LJSmith.com

Installation hardware included with panels and posts:



1/2" x 1 1/2" rectangular tube construction with .065 wall thickness

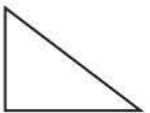

Designed for 7 1/2" Rise and 10" Run (36.9°)

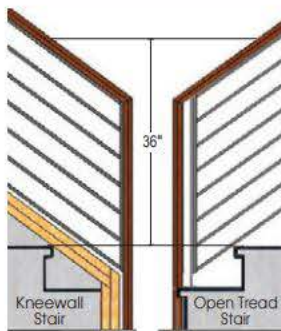

36" Rake rail height and 36", 39" or 43" level run rail heights. Rail heights may vary due to field conditions or preferences



Five rake panel widths



Seven level panel widths



Standard finish is Low Sheen Black. Other powder coat and Pantone paint colors can be quoted.

Kneewall Stair Panels

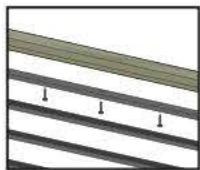

Every rake and level panel is predrilled on the top rung and comes with screws for attachment to the handrail. Screws are also included for the bottom of each panel.

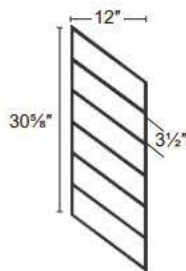

PR-K1236
15"
Actual Rake Length



PR-K1836
22 1/2"
Actual Rake Length

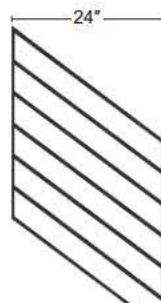

PR-K2436
30"
Actual Rake Length

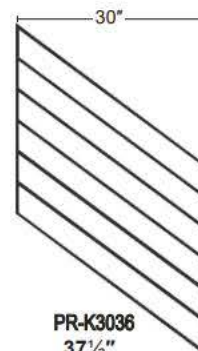

PR-K3036
37 1/2"
Actual Rake Length

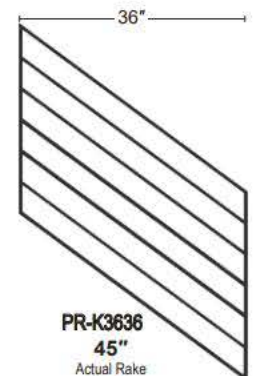

PR-K3636
45"
Actual Rake Length

Open Tread Stair Panels

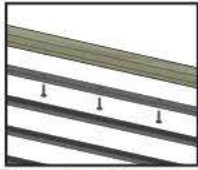

Every rake and level panel is predrilled on the top rung and comes with screws for attachment to the handrail. Screws are also included for the bottom of each panel.

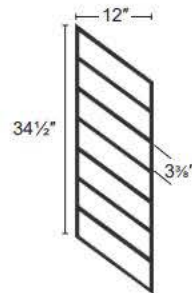

PR-O1236
15"
Actual Rake Length



PR-O1836
22 1/2"
Actual Rake Length

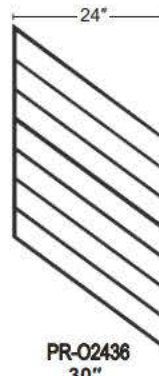

PR-O2436
30"
Actual Rake Length

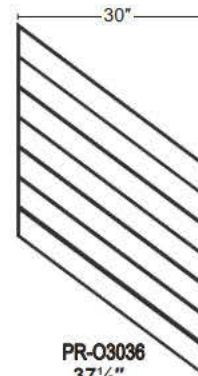

PR-O3036
37 1/2"
Actual Rake Length

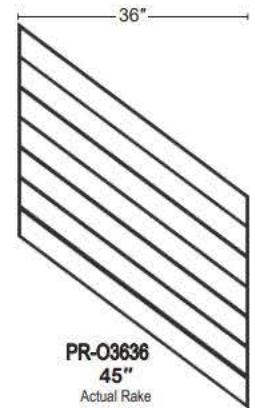

PR-O3636
45"
Actual Rake Length

Level Run Panels

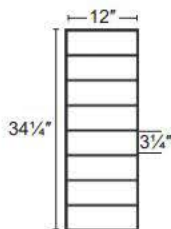

PL-CE1239
39" Rail Height
Curb Wall or Elevated



PL-CE1839
39" Rail Height
Curb Wall or Elevated



PL-CE2439
39" Rail Height
Curb Wall or Elevated

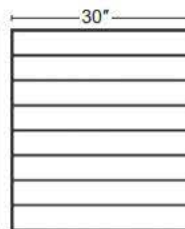

PL-CE3039
39" Rail Height
Curb Wall or Elevated

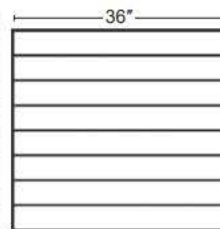

PL-CE3639
39" Rail Height
Curb Wall or Elevated

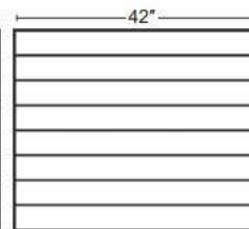

PL-CE4239
39" Rail Height
Curb Wall or Elevated

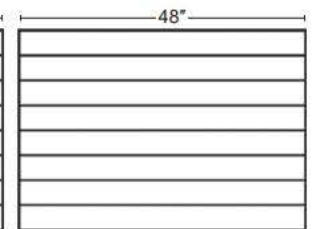

PL-CE4839
39" Rail Height
Curb Wall or Elevated

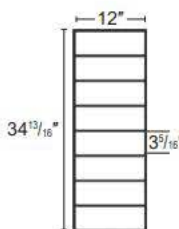

PL-F1236
36" Rail Height
Flush Mount



PL-F1836
36" Rail Height
Flush Mount



PL-F2436
36" Rail Height
Flush Mount

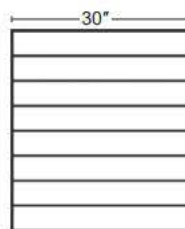

PL-F3036
36" Rail Height
Flush Mount

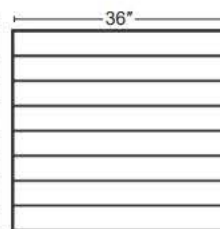

PL-F3636
36" Rail Height
Flush Mount

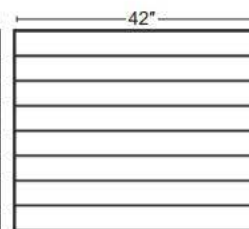

PL-F4236
36" Rail Height
Flush Mount

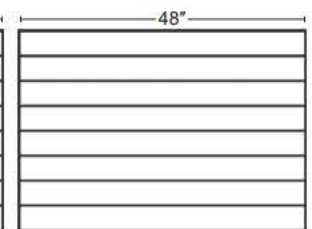

PL-F4836
36" Rail Height
Flush Mount

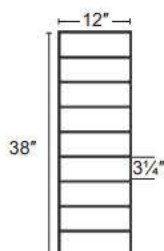

PL-CE1243
43" Rail Height
Curb Wall or Elevated



PL-CE1843
43" Rail Height
Curb Wall or Elevated



PL-CE2443
43" Rail Height
Curb Wall or Elevated



PL-CE3043
43" Rail Height
Curb Wall or Elevated

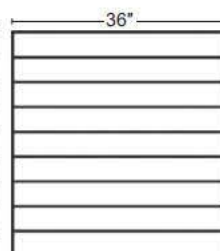

PL-CE3643
43" Rail Height
Curb Wall or Elevated

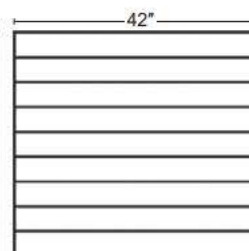

PL-CE4243
43" Rail Height
Curb Wall or Elevated

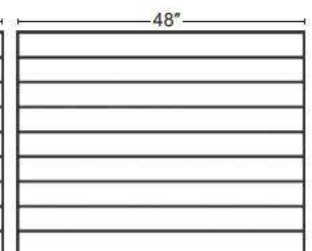

PL-CE4843
43" Rail Height
Curb Wall or Elevated

PL-F1239
39" Rail Height
Flush Mount

PL-F1839
39" Rail Height
Flush Mount

PL-F2439
39" Rail Height
Flush Mount

PL-F3039
39" Rail Height
Flush Mount

PL-F3639
39" Rail Height
Flush Mount

PL-F4239
39" Rail Height
Flush Mount

PL-F4839
39" Rail Height
Flush Mount

Stairway Anatomies

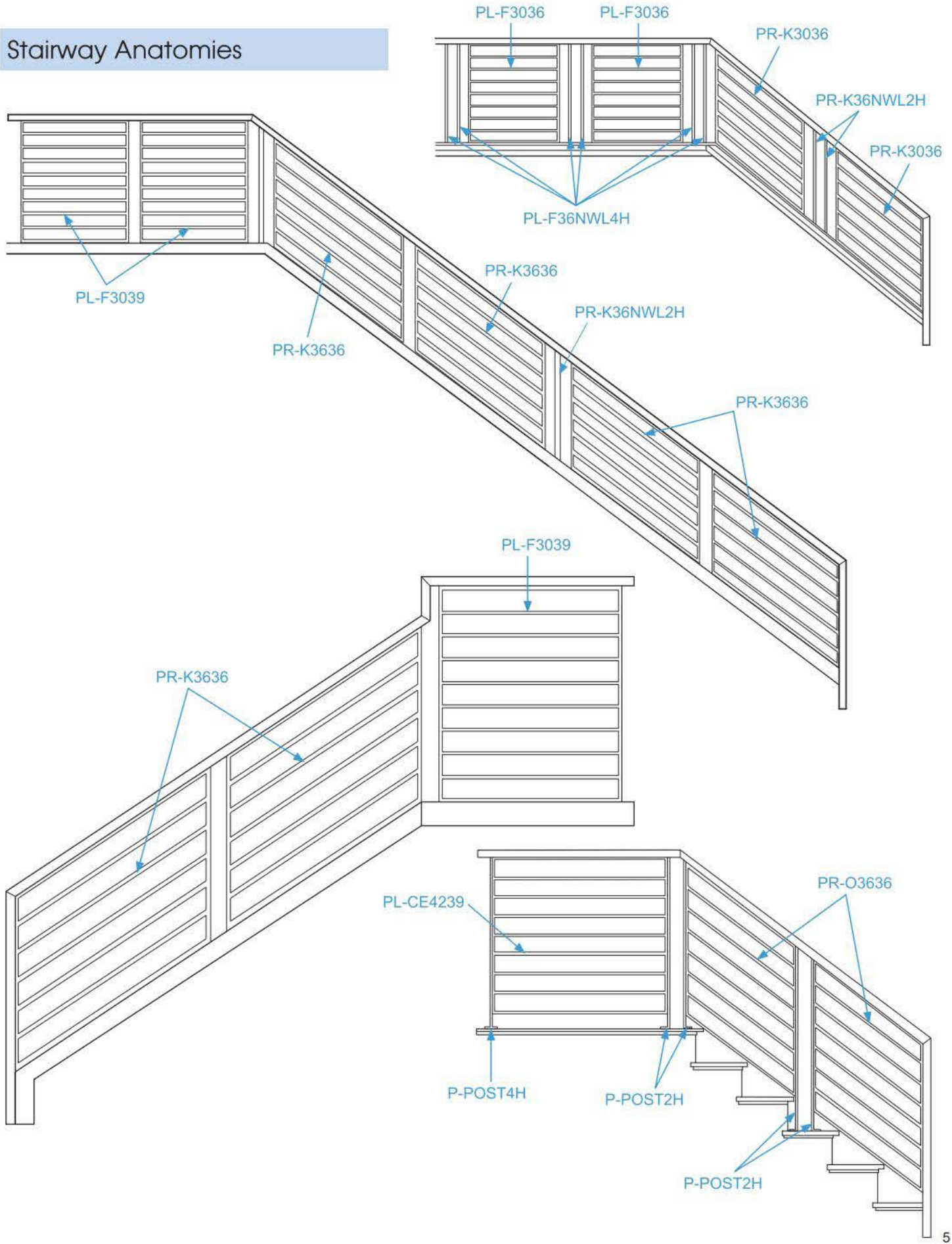



Consult your local building code official before purchasing and installing this system. Due to the nature of wood, the tension on the cables will need periodic adjustment by using two 3/8" open end wrenches as described in the installation instructions. Please contact your L.J. Smith dealer or representative if you have any questions about our Linear Collection products.



Metal-Wood Stair Systems & Railing

www.stairsolutions.com

770-813-9070

Alpharetta, Georgia